

621-2

Thermostat Application Guide

Description	
Gas or Oil Heat	Yes
Electric Furnace	Yes
Heat Pump (No Aux. or Emergency Heat)	Yes
Heat Pump (With Aux. or Emergency Heat)	Yes
Multi-Stage Systems	Yes
Heat Only Systems	Yes
Heat Only Systems - Floor or Wall Furnace	Yes
Cool Only Systems	Yes
Millivolt	Yes

Table of Contents Page

Specifications	1
Installation Tips	2-3
Thermostat Quick Reference	4
Wiring	5
Wiring Diagrams	6
Technician Setup	7-8

Power Type

Battery Power
 Hardwire (Common Wire)
 Hardwire (Common Wire) with Battery Backup

A trained, experienced technician must install this product.

Carefully read these instructions. You could damage this product or cause a hazardous condition if you fail to follow these instructions.

Una version en español de este manual se puede descargar en la pagina web de la compañía.

Wall Locations

The thermostat should be installed approximately 4 to 5 feet above the floor. Select an area with average temperature and good air circulation.

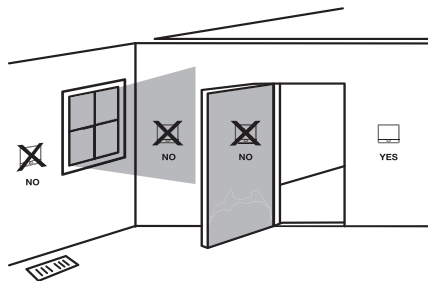

Installation Tip

Pick an installation location that is easy for the user to access. The temperature of the location should be representative of the building.

Do not install thermostat in locations:

- Close to hot or cold air ducts
- That are in direct sunlight
- With an outside wall behind the thermostat
- In areas that do not require conditioning
- Where there are dead spots or drafts (in corners or behind doors)
- Where there might be concealed chimneys or pipes

Subbase Installation

- ① Horizontal Mount
- ② Vertical Mount

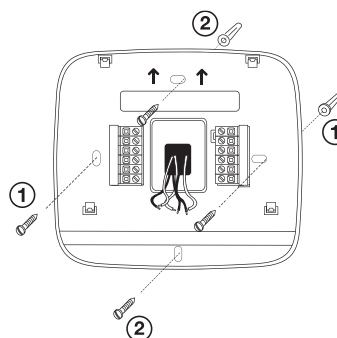

For vertical mount put one screw on the top and one screw on the bottom.
 For horizontal mount put one screw on the left and one screw on the right.



Installation Tip: Electrical Hazard

Failure to disconnect the power before beginning to install this product can cause electrical shock or equipment damage.



Mercury Notice

All of our products are mercury free. However, if the product you are replacing contains mercury, dispose of it properly. Your local waste management authority can give you instructions on recycling and proper disposal or you can mail the thermostat to the address on the warranty section for proper disposal.

Specifications

The display range of temperature ... 41°F to 95°F (5°C to 35°C)
 The control range of temperature... 44°F to 90°F (7°C to 32°C)
 Swing (cycle rate or differential) Heating is adjustable from 0.2° to 2.0°
 Cooling is adjustable from 0.2° to 2.0°
 Power source 18 to 30 VAC, NEC Class II, 50/60 Hz for hardwire
 Battery power from 2 AA Alkaline batteries
 Operating ambient 32°F to +105°F (0°C to +41°C)
 Operating humidity 90% non-condensing maximum
 Dimensions of thermostat 4.7"W x 4.4"H x 0.8"D

① © U.S. Registered Trademark. Patents pending
 Copyright © 2019 All Rights Reserved.

Rev. 1918

②

Installation Tips

Mount Thermostat

Align the 4 tabs on the subbase with corresponding slots on the back of the thermostat, then push gently until the thermostat snaps in place.

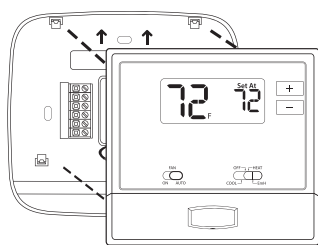

Battery Installation

Battery installation is recommended even if thermostat is hardwired (C terminal connected). When thermostat is hardwired and batteries are installed, the thermostat will activate a compressor delay of 5 minutes when the thermostat detects a power outage from the hardwired power supply.

Important:

High quality alkaline batteries are recommended. Rechargeable batteries or low quality batteries do not guarantee a 1-year life span.

Insert 2 AA Alkaline batteries (included). High quality alkaline batteries are recommended.

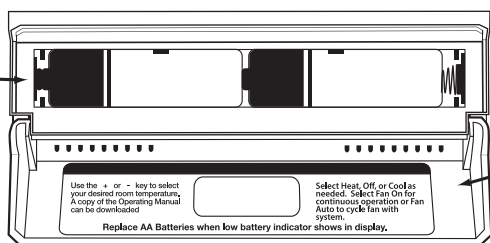

Simple operating instructions are found on the back of the battery door.

Conventional & Heat Pump

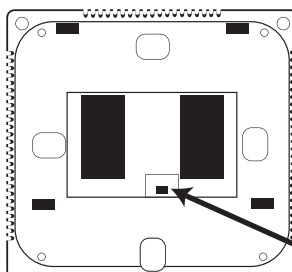

The switch converts the thermostats between conventional and heat pump operation.

Heat Pump: Configures the thermostat for heat pump operations.

Conventional: Configures the thermostat for conventional operations.

Conventional/Heat Pump Switch

Getting to know your thermostat

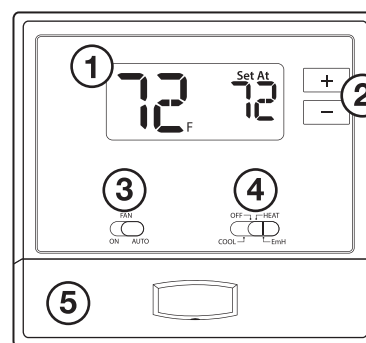

- ① LCD
- ② Temperature setpoint buttons
- ③ Fan switch
- ④ System switch
- ⑤ Easy change battery door

Removing The Private Label Badge

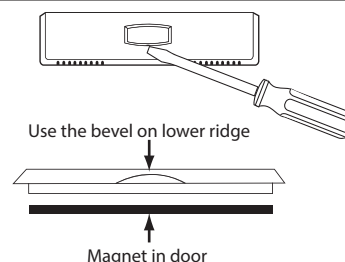

Gently slide a screwdriver into the bottom edge of the badge. Gently turn the screwdriver counter clockwise. The badge is held on by a magnet in the well of the battery door. The badge should pry off easily. **DO NOT USE FORCE.**

About The Badge

All of our thermostats use the same universal magnetic badge. Visit the company website to learn more about our free private label program.

System Operation Indicators:

ON will display when the COOL, HEAT or Emergency Heat is on. Displays the selected setpoint temperature.

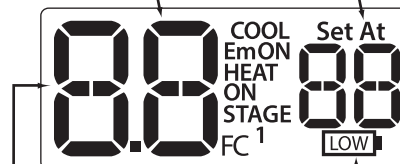

Indicates the current room temperature. **Low Battery Indicator:** Replace batteries when indicator is shown.

NOTE: The compressor delay feature is active if ON is flashing. The compressor will not turn on until the 5 minute delay has elapsed.



Important

The low battery icon is displayed when the AA battery power is low. Whenever the thermostat detects low battery voltage from the AA batteries, the low battery icon will begin flashing on the screen for 21 days (if the batteries are not changed). If the batteries are not changed 22 days after the thermostat detects low battery voltage, the thermostat screen will only show the flashing battery icon until buttons are pressed. If the batteries are not changed 43 days after the thermostat detects low battery voltage, the thermostat screen will only show the flashing battery icon until buttons are pressed and the set points will offset to 85°F/29°C in cooling and 55°F/13°C in heating. At this stage, set point changes can be made temporarily but, the set points will change back to defaulted values after a 4-hour period. The thermostat will continue to perform this low battery flashing, temperature offset condition until the internal voltage threshold is reached. When the thermostat internal voltage threshold is reached, all relays will be opened and the thermostat will become inoperable until new batteries are installed.

③

④



Caution:
Electrical Hazard

Failure to disconnect the power before beginning to install this product can cause electrical shock or equipment damage.



Warning:

All components of the control system and the thermostat installation must conform to Class II circuits per the NEC Code.



1 Power supply



2 Use either O or B terminals for changeover valve.



3 Optional 24 VAC common connection when thermostat is used in battery power mode.



4 Factory-supplied jumper

Wiring

1. If you are replacing a thermostat, make note of the terminal connections on the thermostat that is being replaced. In some cases the wiring connections will not be color coded. For example, the green wire may not be connected to the G terminal.
2. Loosen the terminal block screws. Insert wires then retighten terminal block screws.
3. Place nonflammable insulation into wall opening to prevent drafts.



Installation Tip

Do not overtighten terminal block screws, as this can damage the terminal block. A damaged terminal block can keep the thermostat from fitting on the subbase correctly or cause system operation issues.

Max Torque = 6in-lbs.

Terminal Designations

	Heat Pump System 1 HEAT 1 COOL / 2 HEAT 1 COOL	Conventional System 1 HEAT 1 COOL / 2 HEAT 1 COOL
R	Transformer Power	Transformer Power
C	Transformer Common	Transformer Common
B	Changeover Valve Energized in HEAT	Energized in HEAT
O	Changeover Valve Energized in COOL	Energized in COOL
G	Fan Relay	Fan Relay
W/E	First Stage of Emergency HEAT	First Stage of HEAT
W2	Second Stage of HEAT/ EMERGENCY HEAT	Second Stage of HEAT
Y	First Stage of HEAT and COOL	First Stage of COOL

2H/1C Heat Pump System - Factory Default Setting

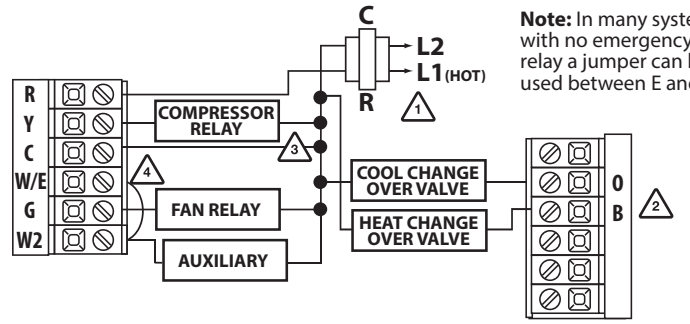

Typical 2H/1C Heat Pump System with separate emergency heat

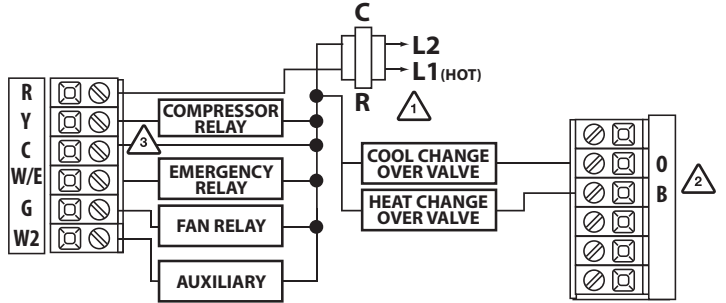

Conventional System 1H/1C, 2H/1C (Heat pump set to "OFF" in tech settings)

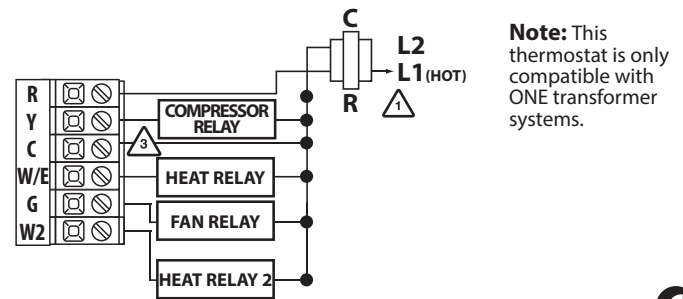

5

Technician Setup

Tech Settings

1. Select OFF with the System Switch.
2. Press and hold the + and - buttons together for 3 seconds.
3. Use the + and - to change setting for that step, press the + and - simultaneously to change between tech settings.

To exit Tech Settings, slide the System Switch to a different position or wait approximately 20 seconds.

Tech Settings	LCD Will Show	Adjustment Options	Default
Room Temperature Calibration	CR 0	You can adjust the room temperature display to read 4° above or below the factory calibrated reading.	0
Compressor Short Cycle Delay	CD ON	Selecting "ON" will not allow the compressor to be turned on for 5 minutes after the last time the compressor was switched off. Select "OFF" to remove this delay.	ON
For C	FC OF	F for Fahrenheit C for Celsius	F
Dual Fuel Auxiliary for Heat Pump	AG OF	OFF will allow Y(1st stage of Heat) and W2 (Aux Heat) to run together if called for. ON Will de-energize Y terminal 45 seconds after a call for Auxiliary Heat (W2).	OFF

6

Technician Setup

Swing and Limit Settings	LCD Will Show	Adjustment Options	Default
Cooling Swing	CO 0.8	The cooling swing setting is adjustable from 0.2° to 2°. For example: A swing setting of 0.5° will turn the cooling on at approximately 0.5° above the setpoint and turn the cooling off at approximately 0.5° below the setpoint.	0.8
Cooling Setpoint Limit	CL 44	This feature allows you to set a minimum cool setpoint value. The setpoint temperature can't be lowered below this value.	44
Heating Swing	HE 0.8	The heating swing setting is adjustable from 0.2° to 2°. For example: A swing setting of 0.5° will turn the heating on at approximately 0.5° below the setpoint and turn the heating off at approximately 0.5° above the setpoint.	0.8
Heating Setpoint Limit	HL 90	This feature allows you to set a maximum heat setpoint value. The setpoint temperature can't be raised above this value.	90

7

8

Operation Manual

Operation Manual

Table of Contents	Page
Table of Contents	1
Thermostat Operation	2-3
Thermostat Quick Reference	4-6
Thermostat Warranty Information	7

Una versión en español de este manual se puede descargar en la página web de la compañía.



Caution

Equipment damage hazard. Do not operate the cooling system if the outdoor temperature is below 50°F (10°C) to prevent possible compressor damage.

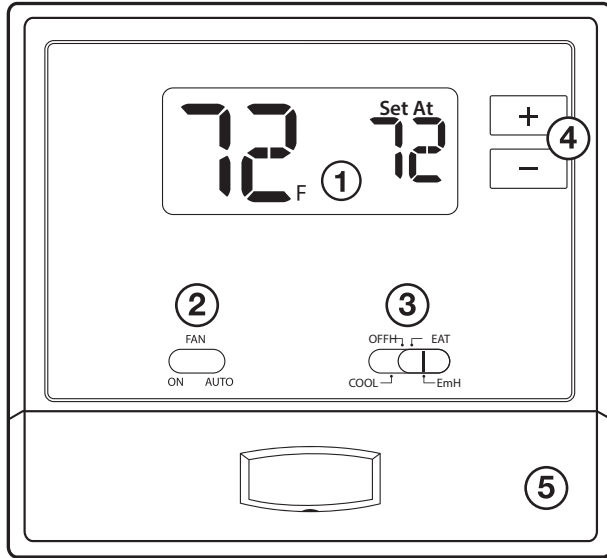

- ① LCD
- ② Fan Switch
- ③ System Switch

- ④ Temperature Setpoint Buttons
- ⑤ Easy change battery door

- ① **LCD Display**
See page 6 for details about this display read out.
- ② **Fan Switch**
Select **ON** or **AUTO**. **ON** will run the fan continuously. **AUTO** will turn the fan on only when the heating or cooling system is on.

Note: The compressor delay is active if "ON" is flashing. The compressor will not turn on until the 5 minute delay has elapsed.

- ③ **System Switch**
Selects the operation mode on your **HVAC** system. Selecting **HEAT** turns on the heat mode. Selecting **COOL** turns on the air conditioning mode. Selecting **OFF** turns both heating and cooling off. Selecting **EmH** locks out your compressor and turns on the secondary heat mode.
- ④ **Temperature Setpoint Buttons**
Press the + or - buttons to select the desired room temperature.
- ⑤ Easy change battery door

Battery Installation

Insert 2 AA Alkaline batteries (included). High quality alkaline batteries are recommended.

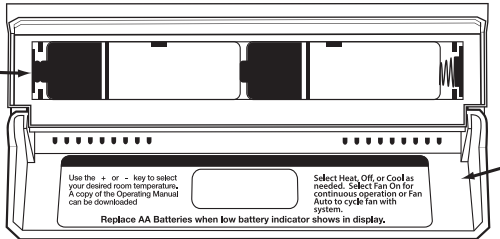

Simple operating instructions are found on the back of the battery door.

Understanding Your Thermostats Staging:

This thermostat controls 2 stages of heating. For reasons of energy efficiency the thermostat will try to maintain your comfort setting using only 1 stage. If the 2nd stage is necessary it will be used and you will see +1 in the display.



Important:

The low battery icon is displayed when the AA battery power is low. Whenever the thermostat detects low battery voltage from the AA batteries, the low battery icon will begin flashing on the screen for 21 days (if the batteries are not changed). If the batteries are not changed 22 days after the thermostat detects low battery voltage, the thermostat screen will only show the flashing battery icon until buttons are pressed. If the batteries are not changed 43 days after the thermostat detects low battery voltage, the thermostat screen will only show the flashing battery icon until buttons are pressed and the set points will offset to 85°F/29°C in cooling and 55°F/13°C in heating. At this stage, set point changes can be made temporarily but, the set points will change back to defaulted values after a 4-hour period. The thermostat will continue to perform this low battery flashing, temperature offset condition until the internal voltage threshold is reached. When the thermostat internal voltage threshold is reached, all relays will be opened and the thermostat will become inoperable until new batteries are installed.

System Operation Indicators:

ON will display when the **COOL**, **HEAT** or **Emergency Heat** is on.

NOTE: The compressor delay feature is active if **ON** is flashing. The compressor will not turn on until the 5 minute delay has elapsed.

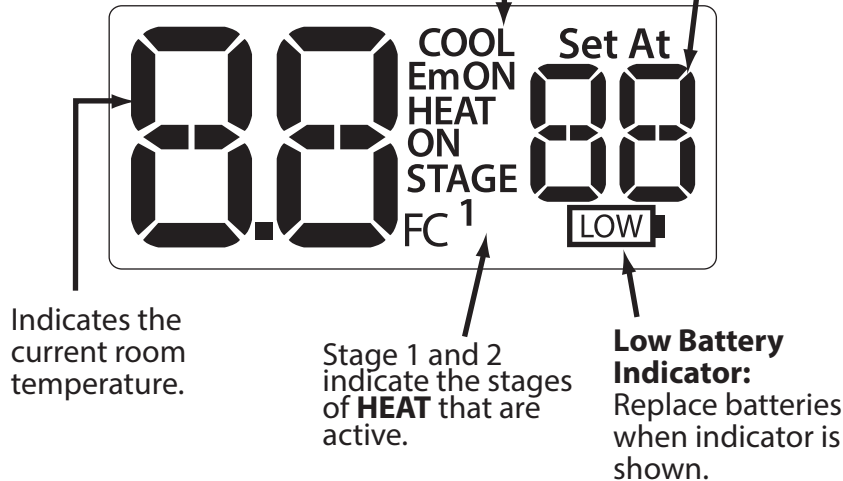

Warranty Registration

Your new thermostat has a 2 year limited warranty. You must register your thermostat within 60 days of installation. Without this registration the warranty period will begin on date of manufacture. For warranty issues please contact the HVAC professional that installed this product. You can register your new thermostat in 2 ways:

Online

Go to the company website, select warranty registration and fill out a short registration form.

Mail

Complete the form below and mail it to the address shown.

Warranty Registration

Name: _____ Thermostat Model: _____

Address: _____ Date Installed: _____

City: _____ Complete form and mail to:

State: _____ **Thermostat Warranty Registration**

Zip: _____ Pro1iaq

P.O. Box 3377
Springfield, MO 65808-3377

**Cut Out For
Warranty Registration**

