

# 955WH

The thermostat and base module contain selectable wireless communication options. Each component has a jumper switch label FSK and ASK. Default setting: FSK.

- All components must be set to the same position for wireless communication.
- Both modes utilize a 916 MHz frequency.
- FSK: frequency-shift keying, is the recommended mode.
- ASK: amplitude-shift keying, should be selected when using components that can not communicate with FSK.

The images below illustrate the location of jumper switches for each item that has one. Note only the thermostat and Base Module are included in this package.

## Thermostat Application Guide

Description	
Gas or Oil Heat	Yes
Electric Furnace	Yes
Heat Pump (No Aux. or Emergency Heat)	Yes
Heat Pump (With Aux. or Emergency Heat)	Yes
Multi-Stage Systems	Yes
Heat Only Systems	Yes
Cool Only Systems	Yes
Millivolt	No
Humidity	Yes
Dual Fuel	Yes

## Power Type

Battery Power\*  
 Hardwire (Common Wire)  
 Hardwire (Common Wire) with Battery Backup

**A trained, experienced technician must install this product.**

Carefully read these instructions. You could damage this product or cause a hazardous condition if you fail to follow these instructions.

Una version en español de este manual se puede descargar en la pagina web de la compañía.

\* If you are using remote sensors the thermostat must be hardwired.

## Table of Contents

	Page
Wireless Type Selection	2
Installation Tips	3-8
Thermostat Quick Reference	9-10
Private Label Badge	11
Wireless Communication Tips	12
Reestablishing Communication	13
Wiring	14-18
Technician Setup Menu	19-28
Setting the Humidity	29
Programming	30-38
Specifications	39

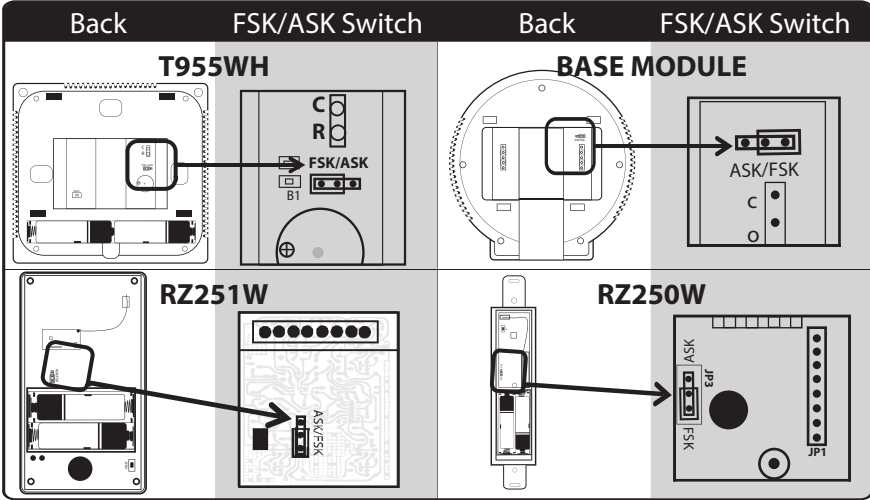

The table below lists the mode options for T955WH wireless thermostat and its accessories.

Component	Mode Options
T955WH Thermostat	FSK or ASK
T955WH Thermostat Base Module	FSK or ASK
RZ251W - Indoor Remote*	FSK or ASK
RZ250W - Outdoor Remote*	FSK or ASK
R251W - Indoor Remote	ASK
R250W - Outdoor Remote	ASK
W150W - Wireless Repeater	ASK

\*Compatible with Z955W - Wireless Zoning Controller

1 © U.S. Registered Trademark. Patents pending  
 Copyright © 2018 All Rights Reserved.

Rev. 1845

2

## Installation Tips

### Wall Locations

The thermostat should be installed approximately 4 to 5 feet above the floor. Select an area with average temperature and good air circulation.

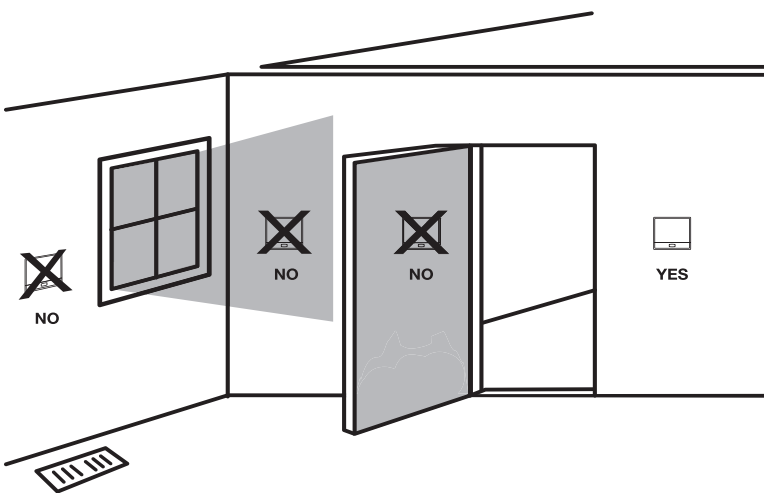

### Do not install thermostat in these locations:

- Close to hot or cold air ducts
- That are in direct sunlight
- With an outside wall behind the thermostat
- In areas that do not require conditioning
- Where there are dead spots or drafts (in corners or behind doors)
- Where there might be concealed chimneys or pipes

### Installation Tip

Pick an installation location that is easy for the user to access. The temperature of the location should be representative of the building.

## Installation Tips

### Thermostat Subbase Installation

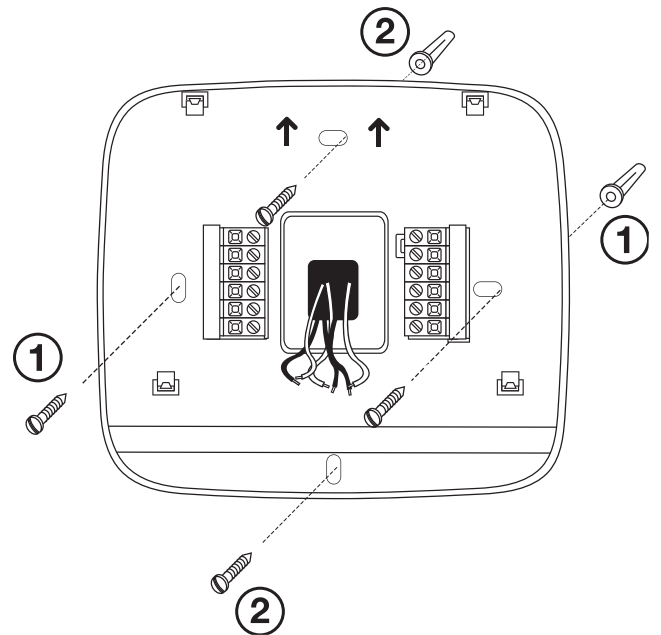

- Horizontal Mount** For horizontal mount put one screw on the left and one screw on the right.
- Vertical Mount** For vertical mount put one screw on the top and one screw on the bottom.

### Installation Tip: Electrical Hazard

Failure to disconnect the power before beginning to install this product can cause electrical shock or equipment damage.

### Mercury Notice

All of our products are mercury free. However, if the product you are replacing contains mercury, dispose of it properly. Your local waste management authority can give you instructions on recycling and proper disposal.

3

4

Base Module Subbase installation

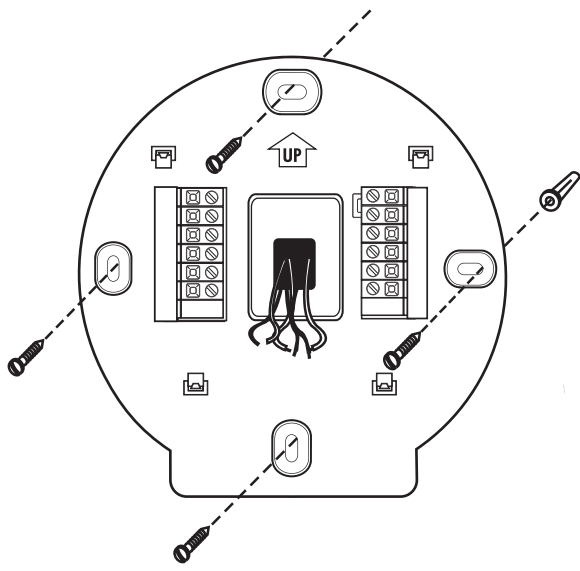

- 1 Horizontal Mount For horizontal mount put one screw on the left and one screw on the right.
- 2 Vertical Mount For vertical mount put one screw on the top and one screw on the bottom.

**Wiring Note**  
Wire the base module's subbase the same way you would wire a hardwired thermostat subbase.

**Note:**  
To connect the base module to the master thermostat, refer to the directions on page 13 of this manual.

**Note:**  
The base module must be hardwired (C and R terminals connected to 24V power.)

Thermostat Quick Reference

Getting to know your thermostat

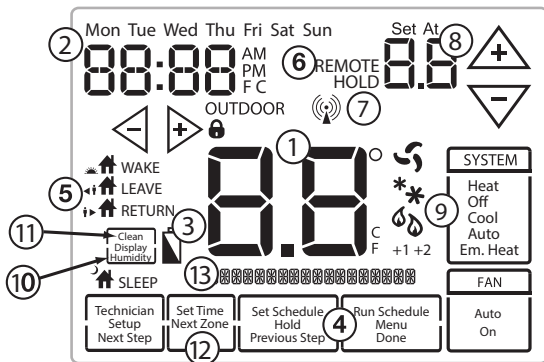

- 1 Indicates the current room temperature
- 2 Time and day of the week
- 3 Low Battery Indicator: Replace batteries when this indicator is shown.
- 4 Program Menu Options: Show different options during programming.
- 5 Period Icons - This thermostat can have 2 or 4 programmable time periods per day. Icons are displayed for 4 time periods. Occupied and unoccupied will display in the text field for 2 time periods.
- 6 REMOTE indicates a remote has control of the system.
- 7 HOLD is displayed when thermostat program is permanently overridden.
- 8 Setpoint: Displays the user selectable setpoint temperature
- 9 System Operation Indicators: The COOL, HEAT or FAN icon will display when the COOL, HEAT or FAN is on. NOTE: The compressor delay feature is active if these icons are flashing. The compressor will not turn on until the 5 minute delay has elapsed.
- 10 Humidity: Shows the humidity target setpoint settings and keys.
- 11 Clean Display: Pressing CLEAN DISPLAY will allow 30 seconds to clean the display. The keys will be inoperable during this time. CLEAN will appear if your contractor has programmed a filter change reminder. Press CLEAN when filter has been replaced to reset the filter change reminder timer.
- 12 Next Zone: This button will appear if optional indoor remotes are present. By selecting NEXT ZONE you can cycle through each of the zones set up during the initial installation.
- 13 System Information: Shows which zone or zones are controlling your system. Shown only when one or more indoor sensors are connected.

Mount Thermostat and Base Module

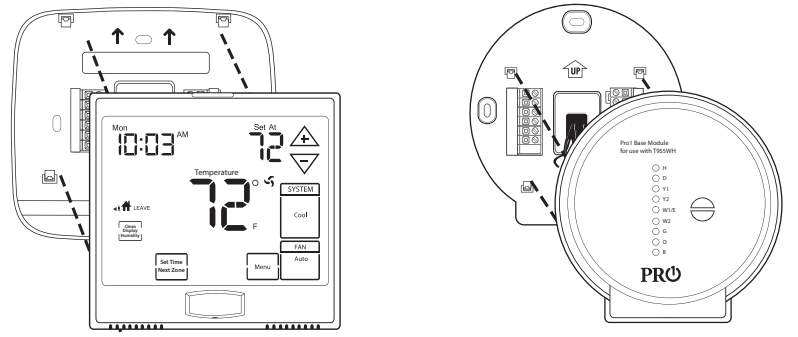

Align the 4 tabs on the subbase with corresponding slots on the back of the thermostat/base module, then push gently until it snaps in place.

**Note:** To ensure a solid fit between the thermostat/base module and the subbase:

- 1. Mount subbase to a flat wall
- 2. Use screws provided
- 3. Drywall anchors should be flush with the wall
- 4. Wires should be pushed into the wall

Battery Installation

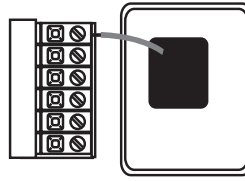

Battery installation is optional if there are no remotes connected to the Master Thermostat (C terminal connected). **If you connect an outdoor remote and/or indoor remote sensors it is required the thermostat be hardwired.**

**Important:** High quality alkaline batteries are recommended. Rechargeable batteries or low quality batteries do not guarantee a 1-year life span.

Insert 2 AA Alkaline batteries (included). High quality alkaline batteries are recommended.

On the back of the thermostat insert 2 AA Alkaline batteries (included).

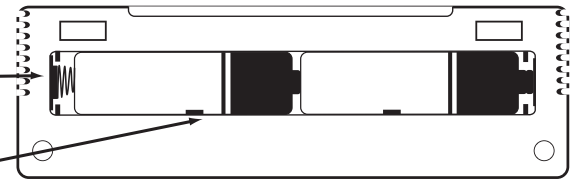

Thermostat Quick Reference

Getting to know your thermostat

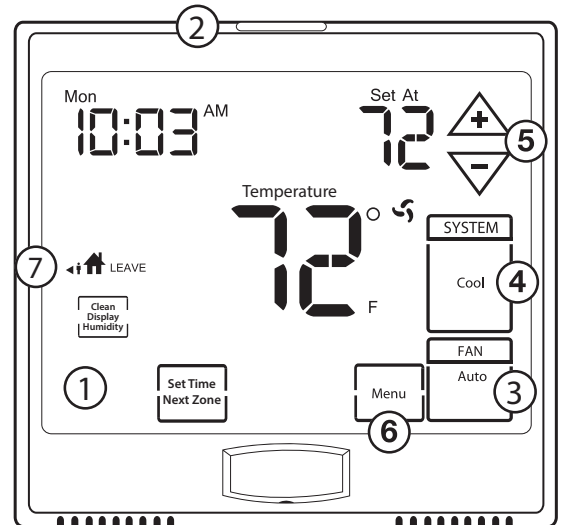

- 1 LCD Display
- 2 Glow in the dark light button
- 3 Fan key
- 4 System key
- 5 Setpoint keys
- 6 Menu key
- 7 Scheduled time period Icons

**Important**

The low battery indicator is displayed when the AA battery power is low. If the user fails to replace the battery within 21 days, the screen will only show the low battery indicator but maintain all functionality. If the user fails to replace the batteries after an additional 21 days (days 22-42 since first "low battery" display) the setpoints will change to 55°F (Heating) and 85°F (Cooling). If the user adjusts the setpoint away from either of these, it will hold for 4 hours then return to either 55°F or 85°F. After day 63 the batteries must be replaced immediately to avoid freezing or overheating because the thermostat will shut the unit off until the batteries are changed.

## Installation Tips

When performing an attic installation, instead of placing the base module in the attic, locate the closet nearest to the air conditioning unit. Then mount the base module high on the wall inside the closet or on the ceiling of the closet. This location will insure the base module is below the 150°F maximum ambient temperature specification.

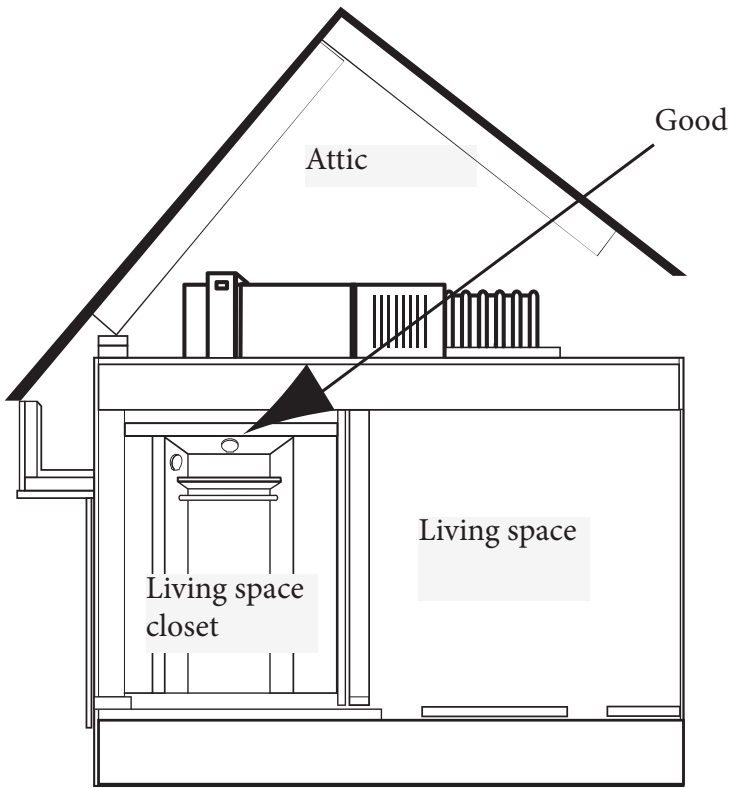

### Installation Tips

#### Do not install the base module in locations:

- That are behind a chimney
- Where temperature could exceed 150°F
- Where rain or snow or extreme hot or cold is possible

**Note: This base module is NOT weatherproof.**

7

## Private Label Badge

### About The Badge

All of our thermostats use the same universal magnetic badge. Visit the company website to learn more about our free private label program.

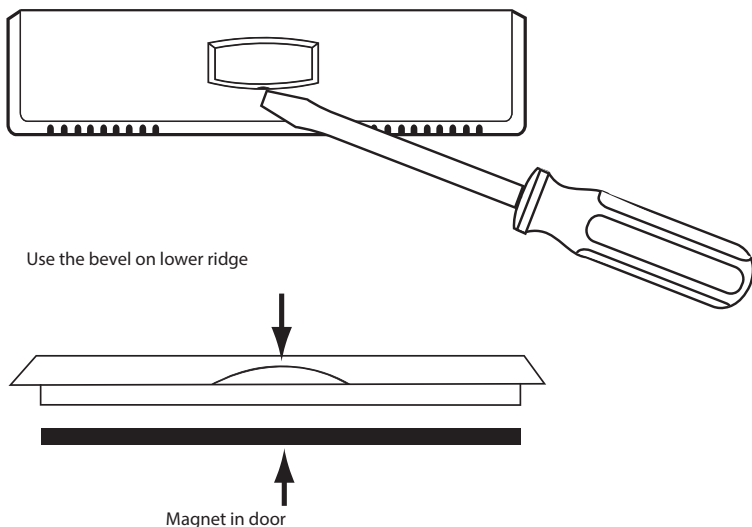

Gently slide a screwdriver into the bottom edge of the badge. Gently turn the screwdriver counter clockwise. The badge is held on by a magnet in the well of the battery door. The badge should pry off easily. **DO NOT USE FORCE.**

11

## Installation Tips

### Base Module - Basement Location

#### Wireless Range

Range between the thermostat and the base module is up to 100 feet with no obstructions and approximately 50 feet in standard residential construction. To extend the range try replacing the base unit higher if in a basement or further away from large metal objects.

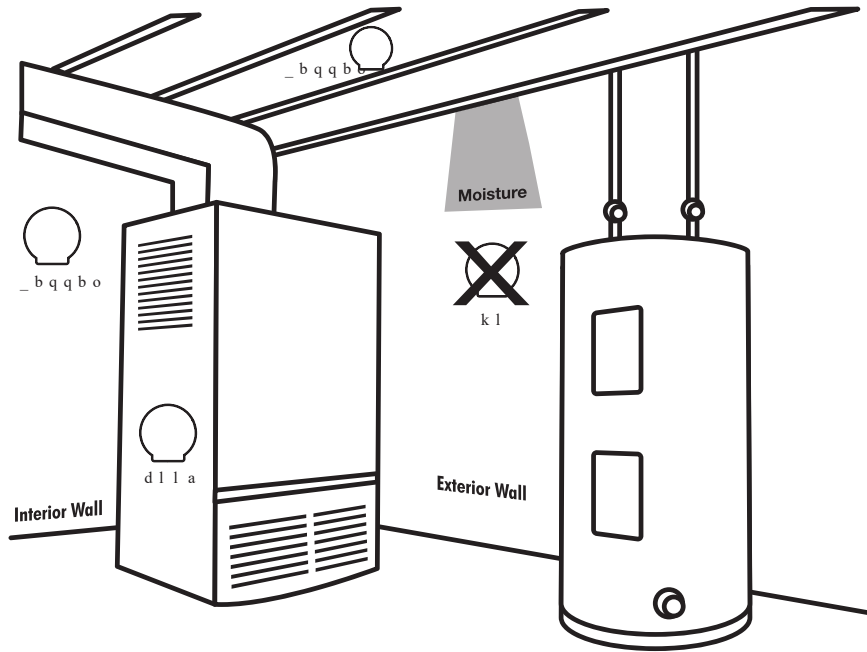

### Installation Tips

Do not install the base module in locations:

- That are behind a chimney
- Where temperature could exceed 150°F
- Where rain or snow or extreme hot or cold is possible

**Note: This base module is NOT weatherproof.**

8

## Wireless Communication Tips

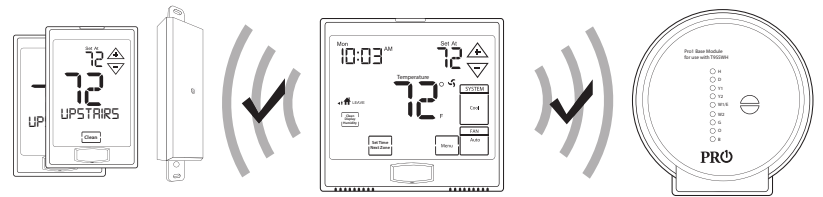

### Follow these steps for a simple wireless communication setup.

- 1 Locate all components in area near equipment.**
- 2 Wire base module with 8ft pigtail and temporarily mount.**  
If you are not able to establish communication, this will allow you to relocate the module to an area with less obstruction, without having to rewire.
- 3 Install batteries in all devices you wish to use.**  
Thermostat, indoor/outdoor sensors.
- 4 A. Press the menu button on thermostat**  
**B. Press & hold tech set up button**  
**C. Configure the set up for your application**  
**D. Establish communication between devices**
- 5 Install thermostat in final location.**  
Note: You must hardwire the thermostat when using remotes.
- 6 Turn on fan from thermostat to ensure communication.**  
Once communication is established, permanently mount module.

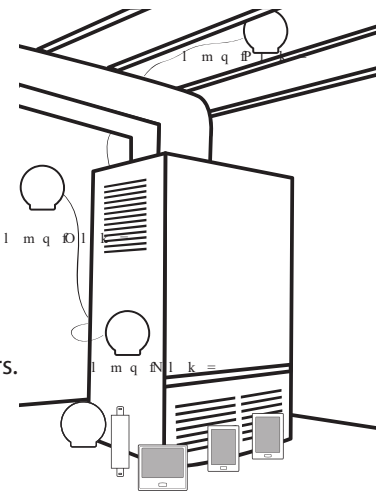

#### Troubleshooting

If there is no communication between the thermostat and base module devices that are less than 50ft. apart, utilize an 8ft. pigtail to relocate and reduce interference. If there is not communication and devices are over 50ft. apart, add a W150W - Wireless Repeater.

12

# Reestablishing Communication

## Establishing communication between master thermostat and the base module

The thermostat and base module come factory linked out of the box. If however, communication is lost, follow this easy- two step process to re-establish the communication link.

1. Press and hold the base module button for 3 seconds. The Blue LED will flash when ready to receive initial signal from the thermostat. (Base module must be powered by 24V. Blue LED will be continuously on when 24V power is present.)

2. Hold the light key (shown here) of the thermostat for 10 seconds, the Blue LED on the base module will stop flashing after communication has been established between base module and the thermostat.

**Note:** The blue LED on the base module will be on when power is present. The blue LED will flash 3 times everytime it receives a signal from the thermostat. When a relay is on the corresponding LED relay indicator will be on.

**Note:** If the base module does not receive a signal from the thermostat for 15 minutes it will turn off all relays until communication is reestablished. The blue LED base module will also turn off to show communication has been lost.

**Note:** If communication has been lost for 1 hour and if freeze protection is enabled, heat and emergency heat relays will be turned on. The heat and emergency relays will turn on for 10 minutes every hour if there has been a call for heat in the last 24 hours.

### Step 1.

LED Relay Indicators Blue LED

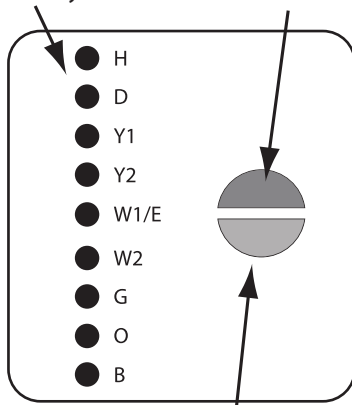

Base Module Button

### Step 2.

Light key

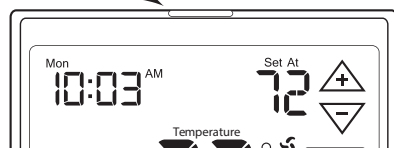

**Important:** DO NOT hold the light button on the thermostat for more than 10 seconds after step 2 above has been completed. Holding the light button down will break the communication link and the base module button will need to be pressed again to reestablish communication.

# Wiring



## Caution: Electrical Hazard

Failure to disconnect the power before beginning to install this product can cause electrical shock or equipment damage.



## Warning:

All components of the control system and the thermostat installation must conform to Class II circuits per the NEC Code.

## Wiring

1. If you are replacing a thermostat, make note of the terminal connections on the thermostat that is being replaced. In some cases the wiring connections will not be color coded. For example, the green wire may not be connected to the **G** terminal.
2. Loosen the terminal block screws. Insert wires then retighten the terminal block screws.
3. Place nonflammable insulation into the wall opening to prevent drafts.



## Installation Tip

Do not overtighten terminal block screws, as this can damage the terminal block. A damaged terminal block can keep the thermostat from fitting on the subbase correctly or cause system operation issues.

**Max Torque = 6in-lbs.**

## Wiring Tips

### C Terminal

The C (common wire) terminal does not have to be connected when the thermostat is powered by batteries.

### Wire Specifications

Use shielded or non-shielded 18-22 gauge thermostat wire.

### Note:

In many heat pump systems with no emergency heat relay, a jumper can be installed between **E** and **W2** to turn thermostat into a single stage control for Emergency Heat Operation.

13

14

# Wiring

- 1 Power supply
- 2 Factory-installed jumper. Remove only when installing on 2-transformer systems
- 3 Use either O or B terminals for changeover valve
- 4 If DEHUM relay requires a normally-energized input, set dehumidify relay to NC in technician setup.

## Typical 2H/2C System: 2 Transformer

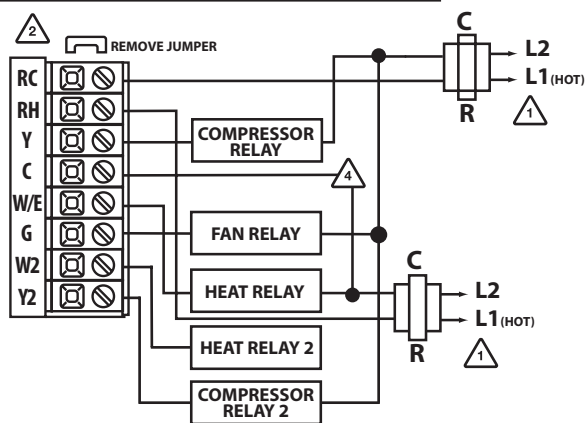

## Typical 2H/2C system with dehum terminal

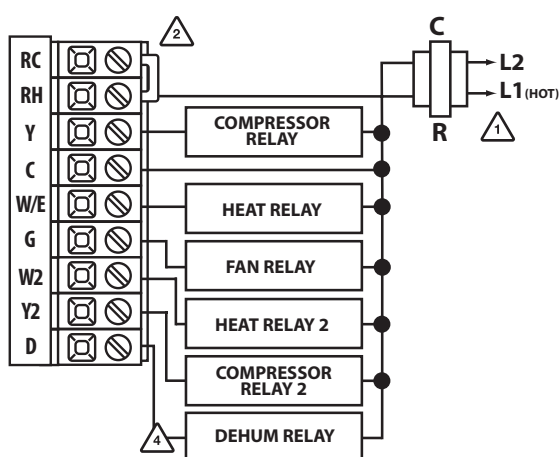

# Wiring

- 1 Power supply
- 2 Factory-installed jumper. Remove only when installing on 2-transformer systems
- 3 Use either O or B terminals for changeover valve
- 4 If DEHUM relay requires a normally-energized input, set dehumidify relay to NC in technician setup.

## Typical 2H/2C System with 24VAC Humidifier

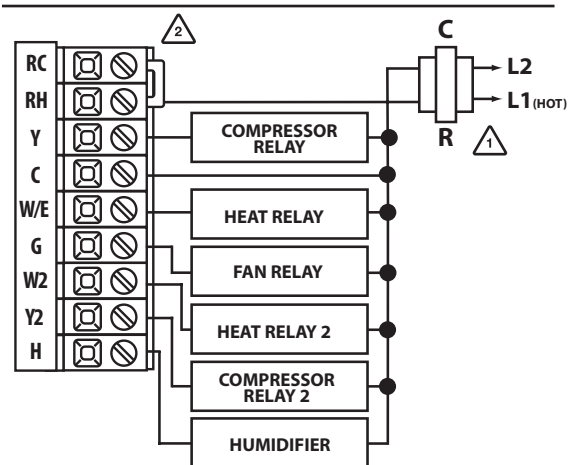

## Typical 2H/2C System with dry contact humidifier

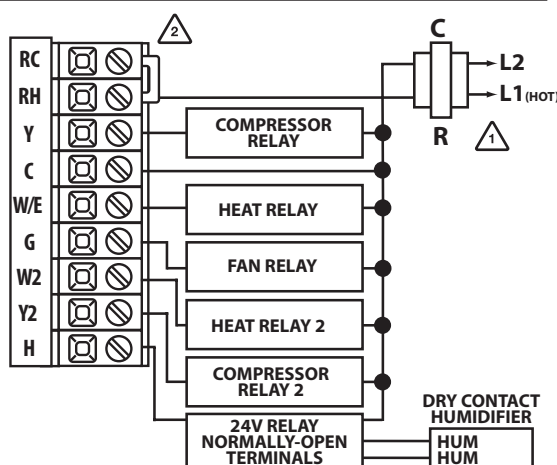

17

18

**Terminal Designations on the Base Module**

This thermostat is shipped from the factory to operate a conventional heating and cooling system. This thermostat may also be configured for a heat pump system. See the "heat pump" configuration step on page 23 of this manual to configure the thermostat for heat pump applications.

Terminal	2 Heat 2 Cool Conventional System	2 Heat 2 Cool Heat Pump System	3 Heat 2 Cool Heat Pump System
RC	Transformer power (cooling)	Transformer power (cooling)	Transformer power (cooling)
RH	Transformer power (heating)	Transformer power (heating)	Transformer power (heating)
C	Transformer common	Transformer common	Transformer common
B	Energized in heating	Heat pump changeover valve energized in heating	Heat pump changeover valve energized in heating
O	Energized in cooling	Heat pump changeover valve energized in cooling	Heat pump changeover valve energized in cooling
G	Fan relay	Fan relay	Fan relay
W/E	First stage of heat	First stage of emergency heat	First stage of emergency heat
Y	First stage of cool	First stage of heat & cool	First stage of heat & cool
Y2	Second stage of cool	Second stage of cool	Second stage of cool & second stage of heat
W2	Second stage of heat	Auxiliary heat relay, second stage of heat	Auxiliary heat relay, third stage of heat
H	Humidify	Humidify	Humidify
D	Dehumidify	Dehumidify	Dehumidify

**Terminal Designations on the Master Thermostat**

Terminal	2 Heat 2 Cool Conventional System	2 Heat 2 Cool Heat Pump System	3 Heat 2 Cool Heat Pump System
R	24 VAC transformer power	24 VAC transformer power	24 VAC transformer power
C	transformer common	transformer common	transformer common

**Powering the Master Thermostat**

If you add indoor or outdoor remote sensors to this wireless system you must hardwire the master thermostat.

- 1 Power supply
- 2 Factory-installed jumper. Remove only when installing on 2-transformer systems
- 3 Use either O or B terminals for changeover valve
- 4 If DEHUM relay requires a normally-energized input, set dehumidity relay to NC in technician setup.

**Typical 2H/2C System: 1 Transformer**

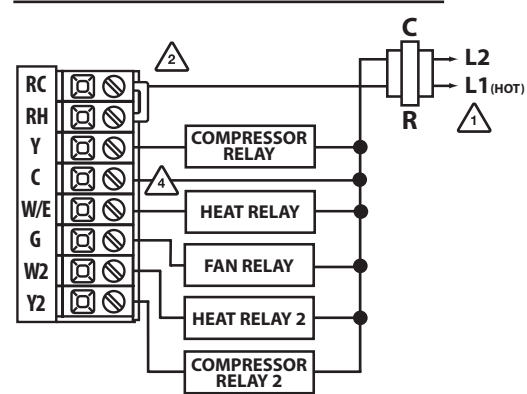

**Typical 3H/2C or 2H/1C Heat Pump System**

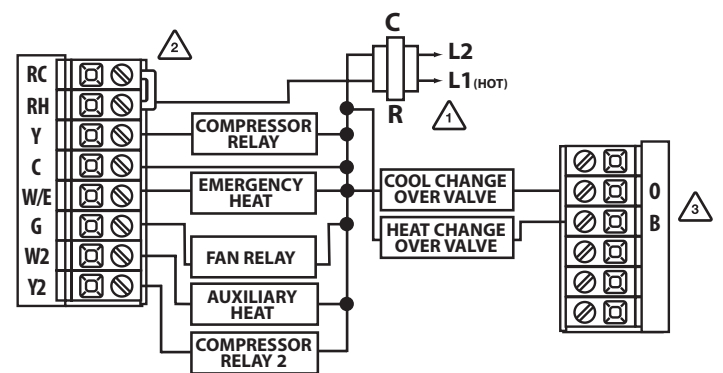

**Technician Setup**

This thermostat has a technician setup menu for easy installer configuration. To set up the thermostat for your particular application:

1. Press the **MENU** button.
2. Press and hold the technician setup button for 3 seconds. This 3 second delay is designed so that homeowners do not accidentally access the installer settings.
3. Configure the installer options as desired using the table below.

Use the or keys to change settings and the next step or previous step key to move from one step to another. **Note:** Only press the **DONE** key when you want to exit the Technician Setup options.

4. Press the **DONE** key to exit.

Tech Setup Steps	LCD Will Show	Adjustment Options	Default
<b>Filter Change Reminder</b> This feature will flash a reminder after the elapsed run time to remind the user to change the filter. A setting of "OFF" will disable this feature.	OFF FILTER 0000	You can adjust the filter change reminder from "OFF" to 2000 hours of fan runtime in 50 hour increments.	OFF
<b>Room Temperature Calibration</b> This feature allows the installer to change the calibration of the room temperature display. For example, if the thermostat reads 70° and you would like it to read 72° then select +2.	0 CALIBRATE	You can adjust the room temperature display to read up to 4° above or below the factory calibrated reading.	0°F
<b>Minimum Compressor On Time</b> This feature allows the installer to select the minimum run time for the compressor. For example, a setting of 4 will force the compressor to run for at least 4 minutes every time the compressor turns on, regardless of the room temperature.	OFF ON AN	You can set the minimum compressor run time to "OFF", "3", "4", or "5" minutes. If 3, 4 or 5 is selected, the compressor will run for at least the selected time before turning off.	OFF

**Keypad Lockout Note:** The selected keypad lockout functionality must be activated after exiting tech setup. If you do not perform this procedure, all keys will function freely. To lock the keypad hold down the and keys for 3 seconds. You will see a lock in the display. To unlock the display hold down the and keys for 3 seconds.

**Technician Setup**

Tech Setup Steps	LCD Will Show	Adjustment Options	Default
<b>Compressor Short Cycle Delay</b> The compressor short cycle delay protects the compressor from "short cycling". This feature will not allow the compressor to be turned on for 5 minutes after it was last turned off.	ON OF CO	Selecting "ON" will not allow the compressor to be turned on for 5 minutes after the last time the compressor was on. Select "OF" to remove this delay.	ON
<b>Cooling Swing</b> The swing setting often called "cycle rate", "differential" or "anticipation" is adjustable. A smaller swing setting will cause more frequent cycles and a larger swing setting will cause fewer cycles.	0.5 dF CO	The cooling swing setting is adjustable from 0.2° to 2°. For example: A swing setting of 0.5° will turn the cooling on at approximately 0.5° above the setpoint and turn the cooling off at approximately 0.5° below the setpoint.	0.5°
<b>Heating Swing</b> The swing setting often called "cycle rate", "differential", or "anticipation" is adjustable. A smaller swing setting will cause more frequent cycles and a larger swing setting will cause fewer cycles.	0.5 dF HE	The heating swing setting is adjustable from 0.2° to 2°. For example: A swing setting of 0.5° will turn the heating on at approximately 0.5° below the setpoint and turn the heating off at 0.5° above the setpoint.	0.4°
<b>Keypad Lockout</b> Keypad lockout allows you to configure the thermostat so that some or all of the keys don't function.	PA	PA= partial keypad lockout, which locks all the keys except the  or  keys. FU= full keypad lockout, which locks out all the keys.	PA

**Swing Setting Tip**

The second stage will turn on at 2x the swing setting. The second stage will turn off when 1x the swing is reached. For example, if the swing setting is .5 degrees for heating and the thermostat is set at 70°F, the first stage will turn on at approximately 69.5°F. The second stage will turn on at 69°F. The second stage will turn off at 69.5°F and the first will turn off at 70.5°F. If the third stage is used, it will turn on at 68.5°F and turn off at approximately 69°F.

## Technician Setup

Tech Setup Steps	LCD Will Show	Adjustment Options	Default
<b>Heating Temperature Setpoint Limit</b> This feature allows you to set a maximum heating setpoint limit. The setpoint temperature cannot be raised above this value.		Use the $\Delta$ or $\nabla$ key to select the maximum heat setpoint.	90°F
<b>Cooling Temperature Setpoint Limit</b> This feature allows you to set a minimum cooling setpoint limit. The setpoint temperature cannot be lowered below this value.		Use the $\Delta$ or $\nabla$ key to select the minimum cool setpoint.	44°F
<b>°F or °C</b> This feature allows you to display temperatures in either Fahrenheit or Celsius.		°F for Fahrenheit °C for Celsius	°F
<b>12 or 24 Hour Clock</b> You can select either a 12 or 24 hour clock setting.		Use the $\leftarrow$ or $\rightarrow$ key to select 12 or 24 hour clock.	12 HOUR CLOCK
<b>Morning Recovery</b> This feature will start heating early to bring the building temperature to its programmed setpoint by the beginning of the WAKE, OCCUPIED time period.		Use the $\leftarrow$ or $\rightarrow$ key to turn on or off.	ON
<b>Program Options</b> You can configure this thermostat to have a 7 day program, a 5+1+1 program or as nonprogrammable.		Use the $\leftarrow$ or $\rightarrow$ key to select 7d for 7 day, 5d for 5+1+1, or 0d for nonprogrammable.	5d
<b>Time Periods</b> You can configure this thermostat to have 2 or 4 programmable time periods per day. 4 time periods are Wake, Leave, Return & Sleep. 2C time periods are Occupied & Unoccupied. 4C time periods are Occupied 1, Unoccupied 1, Occupied 2, & Unoccupied 2.		Use the $\leftarrow$ or $\rightarrow$ key to select 4, 2c, or 4c time periods per day.	4

## Technician Setup

Tech Setup Steps	LCD Will Show	Adjustment Options	Default
<b>Pre-Occupancy Fan</b> The pre-occupancy fan settings will energize the fan before the occupied time to provide ventilation prior to scheduled occupancy. This feature only shows if the technician setup step for time periods is set to 2C or 4C.		You can select the pre-occupancy fan from OFF, 1, 2, or 3 hours.  If 1, 2, or 3 is selected, the fan will turn on that many hours prior to the scheduled occupied time period.	OFF
<b>Display Light</b> The display light can be configured to stay on all the time or come on when any key is pressed. NOTE: HARDWARE ONLY Keeping the display light continually "ON" will greatly reduce battery life.		Use the $\leftarrow$ or $\rightarrow$ key to turn on or off. OFF configures the display light to come on when the light key or any button is pressed. ON configures the display light to stay on.	OFF
<b>Contractor Call Number</b> Allows you to put your phone number in the display. You can choose ON or OFF.		If selected ON, you will see the input screen after pressing <b>NEXT STEP</b> . Use the $\Delta$ or $\nabla$ key to select the desired number and the $\leftarrow$ or $\rightarrow$ key to move from one character to another. See note below for operation.	OFF
<b>Beep</b> When any key is pressed an audible beep will sound. You can choose ON or OFF.		If ON is selected the beep will sound.  If OFF is selected there is no sound.	ON

### Contractor Call Number Note

If contractor call number is selected ON, the phone number entered will show in the display if there has been a continuous call for heating or cooling for 24 hours or if the light button is held down for 3 seconds. To remove the phone number from the display, hold the light button down for 3 seconds.

21

## Technician Setup

Tech Setup Steps	LCD Will Show	Adjustment Options	Default
<b>Stages of Heat</b> You can configure the thermostat to operate a 3 stage heat pump system. 2H 2C = 2 heat, 2 cool 3H 2C = 3 heat, 2 cool This feature is shown only if the HEAT PUMP technician setup step is ON.		Use the $\leftarrow$ or $\rightarrow$ key to change between 2 or 3 stages of heat. 2 heat will use Y1 as first stage and W2 as auxiliary. 3 heat will use Y1 as the first stage, Y2 as the second stage and W2 as the auxiliary.	2 STAGES
<b>Requires Outdoor Sensor</b>			
<b>Balance Point Temp</b> Only shows if Heat Pump is turned ON and Remote Sensor is set to 2.		Use the $\leftarrow$ or $\rightarrow$ to select YES or NO.  If set to YES then use $\Delta$ or $\nabla$ to select Balance point Temperature of 10, 20, 30, 35, 40, 45 or 50 degrees.	
<b>Requires Outdoor Sensor</b> <b>An outdoor temperature ABOVE</b> this setting will LOCKOUT the auxiliary heat terminal (W2), and ONLY ALLOW the heat pump/compressor terminals (Y's) to energize.  <b>An outdoor temperature BELOW</b> this setting can perform 2 different ways, depending on the previous Gas Aux/Dual Fuel setting.  1. If Gas Aux/Dual Fuel is set OFF (Default-typical Electric Aux setting) This will allow both heat pump (Y's) and auxiliary heat (W2) to run together.  2. If Gas Aux/Dual Fuel is set ON (typical Gas Auxiliary/Dual Fuel setting) This will LOCKOUT the heat pump (Y's) and ONLY ALLOW the auxiliary heat (W2) to energize			NO
<b>Balance Point Run Time</b> Balance point run time will allow the W2 auxiliary terminal to energize even if outdoor temperature is above the selected balance point temperature. If enabled, auxiliary will energize for the current cycle after the balance point run time has expired.		YES 15, 30, 45, 60, 75, 90 continuous run time minutes.	NO

22

## Technician Setup

Tech Setup Steps	LCD Will Show	Adjustment Options	Default
<b>Humidify</b> This feature adds humidity when SYSTEM key is in heat. See terminal options on following page.		Use the $\leftarrow$ or $\rightarrow$ key to turn on or off.  If ON is selected the humidity will be displayed on the main screen and HUM terminal will energize when humidity setpoint is above ambient humidity in Heat mode.	OFF
<b>Dehumidify</b> This feature removes humidity when SYSTEM key is in cool. See terminal options on following page.		Use the $\leftarrow$ or $\rightarrow$ key to turn on or off.  If ON is selected the humidity will be displayed on the main screen and DHM terminal will energize when humidity setpoint is below ambient humidity in Cool mode.	OFF
<b>Humidity Calibration</b> This feature allows the installer to change the calibration of the ambient humidity displayed.		Use the $\leftarrow$ or $\rightarrow$ key to adjust the calibration +/-3.  1= approx. 5%	0
<b>Dehumidify with AC</b> This feature forces the A/C to run longer to remove humidity when needed. The A/C will "over cool" the room a few degrees until the humidity reaches the desired setpoint.		Use the $\leftarrow$ or $\rightarrow$ key to select YES or NO.  If selected Yes, allows over cooling to be used to control humidity in cool mode. If NO is selected the system will not use over cooling.	NO
<b>Over Cool Limit</b> The amount of over cooling allowed when using A/C to remove humidity. This screen is only shown when ON is selected in the "Dehumidify with AC" tech setup step.		Use the $\leftarrow$ or $\rightarrow$ key to select the maximum number of degrees of over cool.  Options are: 2, 3, 4, 5 Degrees.	3
<b>HUM Terminal</b> Options for how the HUM terminal energizes.		Use the $\leftarrow$ or $\rightarrow$ key to select the one of the four options.  View the HUM terminal chart below for an explanation of these options.	1

25

26

Tech Setup Steps	LCD Will Show	Adjustment Options	Default
Heat Pump When turned on the thermostat will operate a heat pump. 1. EM. Heat will show as an option in the system switch. 2. Y will be first stage of heat & cool, W/E will be emergency heat relay & W2 will be auxiliary heat relay.	OFF	OFF configures the thermostat for non heat pump systems.  ON configures the thermostat for heat pump systems.	OFF
System Set You can configure the system switch for the particular application. Heat - Off - Cool, Heat - Off, Cool - Off, Heat - Off - Cool - Auto Note: EM. Heat will show if in heat pump mode.	SYSTEM SET	Use the < > key until the desired application is flashing.  AUTO - Auto Changeover	HEAT OFF COOL
Fan Operation Select GAS for systems that control the fan during a call for heat. Select ELEC to have the thermostat control the fan during a call for heat. Will not appear if Heat Pump is "ON".	GAS	GAS or ELEC	GAS
Dual Fuel Auxiliary for Heat Pump For Dual Fuel applications (Gas/ Fossil fuel Auxiliary Heat), turn this setting ON to LOCKOUT the Heat Pump (Y) when Auxiliary Heat (W2) is on. If desired - This can also be used with Electric Auxiliary.  Will only appear if Heat pump setting is turned ON.	OFF  AG	OFF Will allow Y(1st stage of Heat) and W2 (Aux Heat) to run together if called for.  ON Will de-energize Y terminal 45 seconds after a call for Auxiliary Heat (W2).	OFF
Cooling Fan Delay The cooling fan delay setting will delay the fan from coming on in cool mode and keep it running after the compressor shuts off for a short time to save energy in some systems.	OFF  COOL FAN DELAY	You can set the cooling fan delay to OFF, 15, 30, 60 or 90 seconds. If 15, 30, 60, or 90 is selected the fan will not turn on for that many seconds when there is a call for cool and will run for that many seconds after satisfying a call for cool.	OFF

Tech Setup Steps	LCD Will Show	Adjustment Options	Default
Outdoor Sensor Enables the use of an outdoor sensor. Connecting an outdoor sensor allows for a balance point setting. Selecting YES requires the master thermostat to be powered with 24V on C and R terminals. See the outdoor sensor guide for more information.	NO  OUTDOOR SENSOR	When NO is selected the thermostat is unable to connect to an outdoor remote sensor. When YES is selected the thermostat is able to connect to an outdoor remote sensor. Press and hold connect button on outdoor sensor until the master thermostat says FOUND OUTDOOR on display.	NO
Remote Sensor Enables the use of up to four indoor sensors. Selecting YES requires the master thermostat to be powered with 24V on C and R terminals.	NO  REMOTE SENSOR	When NO is selected the thermostat is unable to connect to an indoor remote sensor. When YES is selected the thermostat is able to connect to up to four indoor remote sensors. Go to the next step FINDING SENSOR to connect remote sensors.	NO
Finding Sensor This step connects the indoor sensor with the master thermostat. The previous step remote sensor must be set to YES in order to connect an indoor sensor.	1  FINDING SENSOR	The number shown represents the zone. Use < > to select the zone you wish to connect. The zone setting on the master and the indoor sensors must be the same to connect. See indoor sensors user guide for detailed connection information. See note below for more information.	1
Local Temp Sensor Disable the sensor on the master. At least one indoor remote sensor must be connected to disable the local sensor.	YES  LOCAL TEMP SENSOR	YES enables local sensor. NO disables local sensor.	YES
Freeze Protection Turns on the heat for 10 minutes each hour if unable to communicate with the master thermostat if there has been a call for heat in the last 24 hours.	NO  FREEZE PROTECTION	YES enables freeze protection. NO disables freeze protection.	YES

Tech Setup Steps	LCD Will Show	Adjustment Options	Default
DHM Terminal Option for how DHM terminal energizes.  Note: Set as option 1 if DEHUM with AC is set to YES.	3  DHM TERMINAL	Use the < > key to select the one of the four options.  View the DEHUM terminal chart below for an explanation of these options.	1
Dehumidify Relay You can configure the D Terminal as normally-open or normally closed. NO= Normally Open NC= Normally Closed See Note Below	NO  DEHUMIDIFY DELAY	Use the < > key to select NO or NC. If NO is selected, D will energize to dehumidify. If NC is selected, D will be normally energized. D will de-energize to dehumidify.	NO
Satisfy Setpoint This feature allows the thermostat to keep multiple stages of heat or cool energized until setpoint is satisfied.	OFF  SS STAG ING	Use the < > key to turn on or off.	OFF
Staging Delay This feature allows a delay to occur when a second and third stage is needed. This allows the previous stage extra time to satisfy setpoint.	OFF  STAG ING DELAY	Use the < > key to select the number of minutes to delay each stage.  OFF 5, 10, 15, 30, 45, 60, 90 delay minutes.	OFF

**Note:** When the dehumidify terminal is configured as normally-closed, the base module D terminal LED indicator will be lit when the relay is closed. When the thermostat calls for dehumidification, the D terminal LED indicator will turn off.

HUM Terminal

OPTIONS	HUM terminal energizes when the ambient humidity is...
1	Below the humidity setpoint and heat or fan is energized.
2	Below the humidity setpoint and heat is energized.
3	Below the humidity setpoint. It will also energize the fan during a call for humidity.
4	Below the humidity setpoint.

DHM Terminal

OPTIONS	DUM terminal energizes when the ambient humidity is...
1	Above the humidity setpoint and cool or fan is energized.
2	Above the humidity setpoint. It will also energize the fan during a call for dehumidify.
3	Above the humidity setpoint.
4	Above the humidity setpoint and the compressor is not running.

**Note:**

Up to four indoor temperature sensors can be connected to one thermostat. This allows for 5 sensing points (zones). For example: the local (thermostat) plus four indoor sensors enables 5 sensing points. To connect an indoor sensor to a thermostat, select 1 on the FINDING SENSOR technician setup step. Then hold down the light button on the indoor sensor until it beeps, while in ZONE technician setup step on the indoor sensor. To connect a second indoor sensor change the thermostat to read 2 and change the indoor sensor to zone 2. The zone setting must match between the thermostat and the indoor sensor to connect. When the connection is established the thermostat will show FOUND + NAME of the indoor sensor in the system information area of display.

**Balance Point:**

The system operates differently when a balance point is used. On a dual fuel system, the balance point outdoor temperature setting will be the outdoor temperature at which the thermostat chooses either the heat pump or gas furnace. For example: A balance point setting of 30°F will turn on only the heat pump above 30°F and only the gas furnace below 30°F. Y1 will be stage one above 30°F and W2 will be stage one below 30°F. A heat pump with electric auxiliary will energize the heat pump above and below balance point. The electric auxiliary will only energize below balance point. For Example: A balance point setting of 40°F, will turn on the heat pump above 40°F and turn on the heat pump and electric auxiliary below 40°F.

**Reminders**

Once a reminder has been turned on and set, the elapsed time can be checked by navigating to its tech setup step. The elapsed time will then appear in the text field. It can also be reset at that time by holding down the set **CLEAN** button for 3 seconds. Resetting an expired reminder can be done without entering tech setup, by holding down the set **CLEAN** button for 3 seconds from the home screen.

## Setting The Humidity

### Setting The Humidity

Follow the steps below to change your target humidity setpoint.

Press the humidity button. Use the ◀ or ▶ button to select the target humidity setpoint. Press **DONE** when completed.

**Note:** The target humidity setpoint is not programmable. Unlike temperature, humidity does not change quickly and should not be programmed.

**Note:** Humidity is only energized during heat. Dehumidify is only energized during cool. Heat and cool each have their own target setpoints.

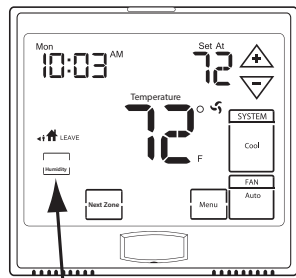

Humidity Key



Target humidity setpoint keys

### Ambient Humidity Display

Ambient humidity will flash opposite the day and time, if the optional outdoor temperature sensor is installed the ambient outdoor temperature will also cycle in the display.

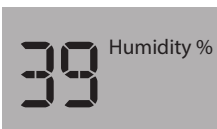

Ambient Humidity

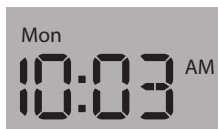

Day & Time



Outdoor Temperature

### Increasing Humidity

The table on the right shows recommended indoor humidity levels in relation to outdoor temperatures during heating (adding humidity).

Consult your professional HVAC technician for recommended settings for your climate.

Outside Temperature (0°)	Recommended Relative Humidity
+20° and above	35% to 40%
+10°	30%
0°	25%
-10°	20%
-20°	15%

## Programming

### Set Time (If using programming)

Follow the steps below to set the day of the week and current time:

1. Press the **MENU** button.
2. Press **Set Time**.
3. Day of the week is flashing. Use the ◀ or ▶ key to select the current day of the week.
4. Press **Next Step**.
5. The current hour is flashing. Use the ◀ or ▶ key to select the current hour. When using 12-hour time, make sure the correct a.m. or p.m. choice is selected.
6. Press **Next Step**.
7. Minutes are now flashing. Use the ◀ or ▶ key to select current minutes.
8. Press **DONE** when completed.

### Programming

All our programmable thermostats are shipped with an energy saving default program. You can customize this default program by following the instructions in the **set program schedule section** starting on page 34.

Your thermostat can be programmed to have each day of the week programmed uniquely (7 days), all the weekdays the same with a separate program for Saturday and a separate program for Sunday (5+1+1), or non-programmable. For the 7-day and 5+1+1 programming modes, there are three time period options.

1. "4" Residential (**WAKE, LEAVE, RETURN, SLEEP**)
2. "2C" Commercial (**OCCUPIED, UNOCCUPIED**)
3. "4C" Commercial (**OCCUPIED 1, UNOCCUPIED 1, OCCUPIED 2, UNOCCUPIED 2**)

This thermostat has a programmable fan feature, which allows you to run the fan continually during any time period.

29

## Programming

Custom Program				
Day of the Week	Events	Time	Setpoint Temperature (HEAT)	Setpoint Temperature (COOL)
Weekday	Wake/OCC1			
	Leave/UNOCC1			
	Return/OCC2			
	Sleep/UNOCC2			
	Occupied			
	Unoccupied			
Saturday	Wake/OCC1			
	Leave/UNOCC1			
	Return/OCC2			
	Sleep/UNOCC2			
	Occupied			
	Unoccupied			
Sunday	Wake/OCC1			
	Leave/UNOCC1			
	Return/OCC2			
	Sleep/UNOCC2			
	Occupied			
	Unoccupied			

33

30

## Programming

### Set Program Schedule For Two Time Periods (OCCUPIED, UNOCCUPIED)

To customize your 5+1+1 Program schedule, follow these steps:

#### Weekday:

1. Select **HEAT** or **COOL** with the **SYSTEM** key.  
**Note:** You have to program heat and cool each separately.
2. Press the **MENU** button (If menu does not appear first, press **RUN SCHED**).
3. Press **SET SCHED**. **Note:** Monday-Friday is displayed and the **OCCUPIED** text is shown. You are now programming the **OCCUPIED** time period for the weekday setting.
4. Use the ◀ or ▶ key to make your time selection for the weekday **OCCUPIED** time period. **Note:** If you want the fan to run continuously during this time period, select **ON** with the **FAN** key.
5. Then use the ▲ or ▼ key to make your setpoint selection for the weekday **OCCUPIED** period.
6. Press **Next Step**.
7. Repeat steps 4 through 6 for the weekday **UNOCCUPIED** time period.

#### Saturday:

Repeat steps 4 through 6 for the Saturday **OCCUPIED** time period and for the Saturday **UNOCCUPIED** time period.

#### Sunday:

Repeat steps 4 through 6 for the Sunday **OCCUPIED** time period, and for the Sunday **UNOCCUPIED** time period.

34



Default Programming

Factory Default Program				
Day of the Week	Events	Time	Setpoint Temperature (HEAT)	Setpoint Temperature (COOL)
Weekday	Wake/OCC1	6 AM	70°F (21°C)	75°F (24°C)
	Leave/UNOCC1	8 AM	62°F (17°C)	83°F (28°C)
	Return/OCC2	6 PM	70°F (21°C)	75°F (24°C)
	Sleep/UNOCC2	10 PM	62°F (17°C)	78°F (26°C)
Saturday	Wake/OCC1	6 AM	70°F (21°C)	75°F (24°C)
	Leave/UNOCC1	8 AM	62°F (17°C)	83°F (28°C)
	Return/OCC2	6 PM	70°F (21°C)	75°F (24°C)
	Sleep/UNOCC2	10 PM	62°F (17°C)	78°F (26°C)
Sunday	Wake/OCC1	6 AM	70°F (21°C)	75°F (24°C)
	Leave/UNOCC1	8 AM	62°F (17°C)	83°F (28°C)
	Return/OCC2	6 PM	70°F (21°C)	75°F (24°C)
	Sleep/UNOCC2	10 PM	62°F (17°C)	78°F (26°C)





Default Programming

Factory Default Program for 2 Time Periods				
Day of the Week	Events	Time	Setpoint Temperature (HEAT)	Setpoint Temperature (COOL)
Weekday	OCCUPIED	8 AM	70°F (21°C)	72°F (22°C)
	UNOCCUPIED	6 PM	64°F (18°C)	80°F (27°C)
Saturday	OCCUPIED	8 AM	70°F (21°C)	72°F (22°C)
	UNOCCUPIED	6 PM	64°F (18°C)	80°F (27°C)
Sunday	OCCUPIED	8 AM	70°F (21°C)	72°F (22°C)
	UNOCCUPIED	6 PM	64°F (18°C)	80°F (27°C)

You can use the table on the next page to plan your customized program schedule if using 5+1+1.

To customize your 7 day program schedule, follow these steps:

Monday:

1. Select **HEAT** or **COOL** with the **SYSTEM** key.  
**Note:** You have to program heat and cool each separately.
2. Press the **MENU** button (If menu does not appear first press **RUN SCHED**).
3. Press **SET SCHED**. **Note:** Monday is displayed and the **OCCUPIED** text is shown. You are now programming the **OCCUPIED** time period for that day.
4. Use the  or  key to make your time selection for the **OCCUPIED** time period. **Note:** If you want the fan to run continuously during this time period, select **ON** with the **FAN** key.
5. Then use the  or  key to make your setpoint selection for that day's **OCCUPIED** period.
6. Press **NEXT**.
7. Repeat steps 4 through 6 for that day's **UNOCCUPIED** time period.

Repeat steps 4 through 6 for the remaining days of the week.

**A Note About Programmable Fan:**





The programmable fan feature will run the fan continuously during any time period it is programmed to be on. This is the best way to keep the air circulated and to eliminate hot and cold spots in your building.

Set Program Schedule For Four Time Periods

(WAKE, LEAVE, RETURN, SLEEP or OCCUPIED 1, UNOCCUPIED1, OCCUPIED 2, UNOCCUPIED 2)

To customize your 5+1+1 Program schedule, follow these steps:

Weekday:

1. Select **HEAT** or **COOL** with the system key.  
**Note:** You have to program heat and cool each separately.
2. Press the **MENU** button (If menu does not appear first press **RUN SCHED**).
3. Press **SET SCHEDULE**. **Note:** Monday-Friday is displayed and the **WAKE/OCC1** icon is shown. You are now programming the **WAKE/OCC1** time period for the weekday setting.
4. Use the  or  key to make your time selection for the weekday **WAKE/OCC1** time period.  
**Note:** If you want the fan to run continuously during this time period, select **ON** with the **FAN** key.
5. Then use the  or  key to make your setpoint selection for the weekday **WAKE/OCC1** period.
6. Press **Next Step**.
7. Repeat steps 4 through 6 for the weekday **LEAVE/UNOCC1** time period, for the weekday **RETURN/OCC2** time period, and for the weekday **SLEEP/UNOCC2** time period.

Saturday:





Repeat steps 4 through 6 for the Saturday **WAKE/OCC1** time period, **LEAVE/UNOCC1** time period, **RETURN/OCC2** time period, and for the Saturday **SLEEP/UNOCC2** time period.

Sunday:

Repeat steps 4 through 6 for the Sunday **WAKE/OCC1** time period, **LEAVE/UNOCC1** time period, **RETURN/OCC2** time period, and for the Sunday **SLEEP/UNOCC2** time period.

To customize your 7 day Program schedule, follow these steps:

Monday:



1. Select **HEAT** or **COOL** with the **SYSTEM** key.  
**Note:** You have to program heat and cool each separately.
2. Press the **MENU** button (If menu does not appear first, press **RUN SCHED**).
3. Press **SET SCHED**. **Note:** Monday is displayed and the **WAKE/OCC1** icon is shown. You are now programming the **WAKE/OCC1** time period for that day.
4. Use the  or  key to make your time selection for that day's **WAKE/OCC1** time period.  
**Note:** If you want the fan to run continuously during this time period, select **ON** with the **FAN** key.
5. Then use the  or  key to make your setpoint selection for that day's **WAKE/OCC1** period.
6. Press **Next Step**.
7. Repeat steps 4 through 6 for that day's **LEAVE/UNOCC1** time period, for that day's **RETURN/OCC2** time period, and for that day's **SLEEP/UNOCC2** time period.



Repeat steps 4 through 6 for the remaining days of the week.

**A Note About Auto Changeover:**

In Auto you have the ability to switch between Auto Heat or Auto Cool by pressing the system key. This can be done once the current mode has reached its setpoint. For example: if in Auto Heat, the heat setpoint must be satisfied before the thermostat will allow you to switch to Auto Cool. You can switch out of Auto by holding down the **SYSTEM** key. To get back into Auto, you must toggle the system key to Auto.

Temporary & Permanent Hold Feature

**Temporary Hold:** The thermostat will display **HOLD** and **Run Schedule** on the bottom of the screen when you press the  or  key. If you do nothing, the temperature will remain at this setpoint temporarily for 4 hours. The program setpoint will then replace the temporary setpoint.

**Permanent Hold:** With a temporary hold set, If you press the **HOLD** key at the bottom of your screen, you will see **HOLD** appear next to the setpoint temperature in the display. The thermostat will now permanently stay at this setpoint and can be adjusted using the  or  keys.

**To Return To Program:** Press the **Run Schedule** key at the bottom of the screen to exit temporary and permanent holds.

Filter Change Reminder

If your installing contractor has configured the thermostat to remind you when the air filter needs changed, you will see a reminder in the display when your air filter needs changed. the reminder will be shown in the display after your system has run long enough to require an air filter change.

Resetting the filter change reminder: When the reminder is displayed, you should change your air filter and reset the reminder by holding down the "**Clean**" key on the left side of the thermostat for 3 seconds.

Specifications

Specifications

- The display range of temperature ... 41°F to 95°F (5°C to 35°C)
- The control range of temperature... 44°F to 90°F (7°C to 32°C)
- Load Rating..... 1 amp per terminal, 1.5 amp maximum all terminals combined
- Swing (cycle rate or differential) ..... Heating is adjustable from 0.2° to 2.0° Cooling is adjustable from 0.2° to 2.0°
- Power source ..... 18 to 30 VAC, NEC Class II, 50/60 Hz for hardwire Battery power from 2 AA Alkaline batteries
- Operating ambient ..... 32°F to +105°F (0°C to +41°C)
- Operating humidity ..... 90% non-condensing maximum
- Dimensions of thermostat ..... 4.7" W x 4.3" H x 1.1" D
- Frequency ..... 916 MHz

Base module

- Load rating ..... 1 amp per terminal, 1.5 amp maximum all terminals combined
- Power source ..... 18 to 30 VAC, NEC class II, 50/60 Hz
- Operating ambient ..... 32°F to +150°F (0° to +65°C)
- Operating humidity ..... 90% non-condensing maximum

Operation Manual

Operation Manual

# 955WH

Table of Contents	Page
Table of Contents	1
Thermostat Operation	2-3
Thermostat Quick Reference	4-7
Setting the Humidity	8-9
Programming	10-16
Features	17-18
Warranty Information	19

Una versión en español de este manual se puede descargar en la página web de la compañía.



## Caution

Equipment damage hazard. Do not operate the cooling system if the outdoor temperature is below 50 °F (10 °C) to prevent possible compressor damage.

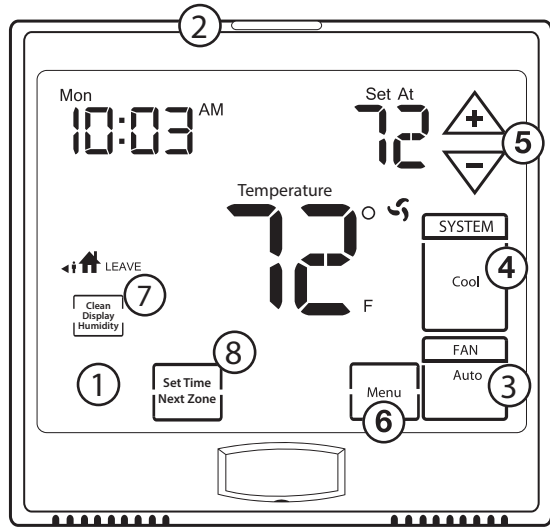

## ① LCD Display

See page 4 for details about this display read out.

## ② Glow in the dark light button

The glow in the dark light button will self illuminate for several hours after exposure to ambient light. This button turns on the display light when pressed.

## ③ Fan Key

Select **ON** or **AUTO**. The **ON** key will run the fan continuously. The **AUTO** key will cycle the fan on only when the heating or cooling system is on. **A Note About Programmable Fan:** The programmable fan feature will run the fan continuously during any time period it is programmed to be on. This is the best way to keep the air circulated and to eliminate hot & cold spots in your building.

## ④ System Key

Selects the operation mode of your HVAC system. Selecting **HEAT** turns on the heat mode. Selecting **COOL** turns on the air conditioning mode. Selecting **OFF** turns both heating and cooling off. Selecting **AUTO** will turn the **HEAT** or **COOL** on as needed.

## ⑤ Temperature Setpoint Buttons

Press the  $\Delta$  or  $\nabla$  buttons to select the desired room temperature.

## ⑥ Menu Key

Use this key to set up your programming options. Refer to page 10 for instructions.

## ⑦ Humidity Key

Use this key to enter the target humidity setpoint screen. Refer to page 8 for instructions.

## ⑧ Next Zone

Use this key for programming or to navigate to multiple zones if using indoor remote sensors.

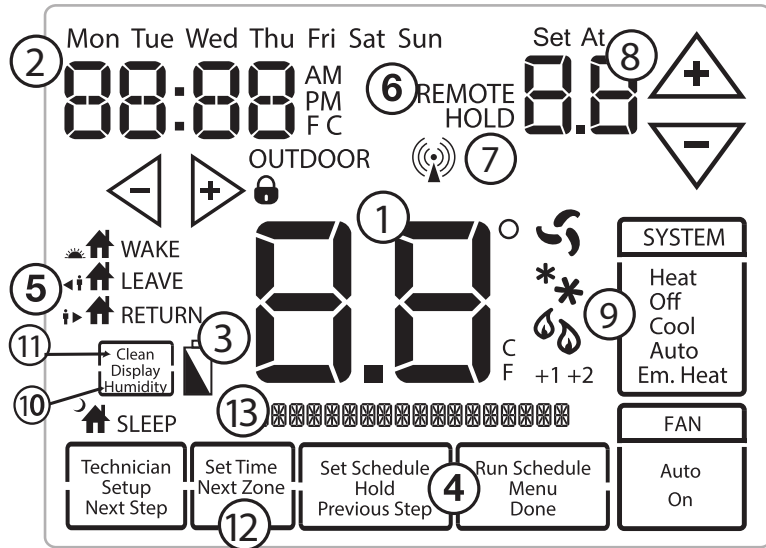

- ① Indicates the current room temperature
- ② Time and day of the week
- ③ **Low Battery Indicator:** Replace batteries when this indicator is shown.
- ④ **Program Menu Options:** Show different options during programming.
- ⑤ **Period Icons** - This thermostat can have 2 or 4 programmable time periods per day. Icons are displayed for 4 time periods. Occupied and Unoccupied will display in the text field for 2 time periods.
- ⑥ **REMOTE** indicates a remote has control of the system.
- ⑦ **HOLD** is displayed when thermostat program is permanently overridden.
- ⑧ **Setpoint:** Displays the user selectable setpoint temperature
- ⑨ **System Operation Indicators:** The **COOL**, **HEAT** or **FAN** icon will display when the **COOL**, **HEAT** or **FAN** is on. **NOTE:** The compressor delay feature is active if these icons are flashing. The compressor will not turn on until the 5 minute delay has elapsed.
- ⑩ **Humidity:** Shows the humidity target setpoint settings and keys.
- ⑪ **Clean Display:** Pressing **CLEAN DISPLAY** will allow 30 seconds to clean the display. The keys will be inoperable during this time. **CLEAN** will appear if your contractor has programmed a filter change reminder. Press and hold **CLEAN** when filter has been replaced to reset the filter change reminder timer.
- ⑫ **Next Zone:** This button will appear if optional indoor remotes are present. By selecting **NEXT ZONE** you can cycle through each of the zones set up during the initial installation and programming.
- ⑬ **System Information:** Shows several different informational functions.

## Battery Door Information

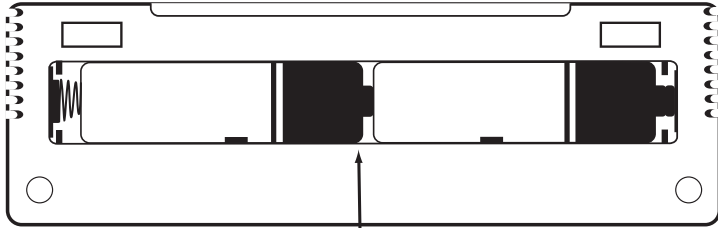

Insert 2 AA Alkaline batteries (included). High quality alkaline batteries are recommended.

Pull the thermostat directly away from the wall to access the batteries. A firm tug will be required to remove the thermostat from the subbase mounted on the wall.



### Caution:

When the battery icon  appears replace your AA batteries immediately. Failure to do so may result in your heating & cooling system becoming inoperable. Freezing or overheating can occur.





### Important:

The low battery indicator is displayed when the AA battery power is low. If the user fails to replace the battery within 21 days, the screen will only show the low battery indicator but maintain all functionality. If the user fails to replace the batteries after an additional 21 days (days 22-42 since first "low battery" display) the setpoints will change to 55°F (Heating) and 85°F (Cooling). If the user adjusts the setpoint away from either of these, it will hold for 4 hours then return to either 55°F or 85°F. After day 63 the batteries must be replaced immediately to avoid freezing or overheating because the thermostat will shut the unit off until the batteries are changed.

## Setting The Humidity

Follow the steps below to change your target humidity setpoint.

Press the humidity button.  
Use the  or  button to select the target humidity setpoint.  
Press **DONE** when completed.

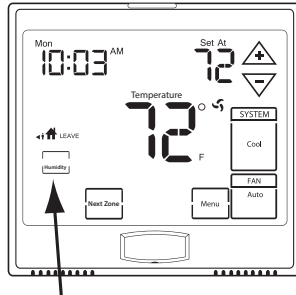

**Humidity Key**

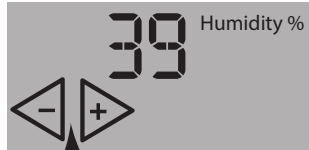

**Target humidity setpoint keys**

**Note:**  
The target humidity setpoint is not programmable. Unlike temperature, humidity does not change quickly and should not be programmed.

**Note:**  
Humidity is only energized during heat. Dehumidify is only energized during cool. Heat and cool each have their own target setpoints.

## Ambient Humidity Display

Ambient humidity will flash opposite the day and time. If the optional outdoor temperature sensor is installed the ambient outdoor temperature will also cycle in the display.

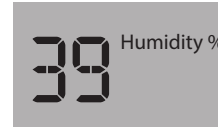

Ambient Humidity

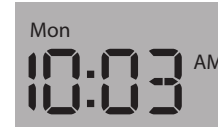

Day & Time



Outdoor Temperature

## Increasing Humidity

The table on the right shows recommended indoor humidity levels in relation to outdoor temperatures during heating (adding humidity).







Consult your professional HVAC technician for recommended settings for your climate.

Outside Temperature (0°)	Recommended Relative Humidity
+20° and above	35% to 40%
+10°	30%
0°	25%
-10°	20%
-20°	15%



## Set Time

Follow the steps below to set the day of the week and current time:

1. Press the **MENU** button.
2. Press **SET TIME**.
3. Day of the week will be flashing. Use the  or  key to select the current day of the week.
4. Press **Next Step**.
5. The current hour is flashing. Use the  or  key to select the current hour. When using 12-hour time, make sure the correct a.m. or p.m. choice is selected.
6. Press **Next Step**.
7. Minutes are now flashing. Use the  or  key to select current minutes.
8. Press **DONE** when completed.

**Important:**

You will see a **TECHNICIAN SETUP** option after the **MENU** key is pressed. This **TECHNICIAN SETUP** key is for installer configuration and should **NOT** be changed unless you consult your professional heating and air conditioning technician.

## Set 5+1+1 Program Schedule

**To customize your 5+1+1 Program schedule, follow these steps:**





**Weekday:**

1. Select **HEAT** or **COOL** with the system key.  
**Note:** You have to program heat and cool each separately.
2. Press the **MENU** key.
3. Press **SET SCHEDULE**. **Note:** Monday-Friday is displayed and the **WAKE** or **OCCUPIED** icon is shown. You are now programming that time period for the weekday setting.

**Additional step if indoor remote sensor is connected.**

The master thermostat will either average all sensors (system average) or only use one sensor for the system ambient temperature (priority). The default setting is **SYSTEM AVERAGE**, which means all sensors are averaged to create the system average ambient temperature reading. The **NEXT ZONE** key can be pressed to change the priority. The system information area of the display shows the priority. For Example: There is a remote connected and it is named **REMOTE 1**. If the **NEXT ZONE** key is pressed until **REMOTE 1** is shown, then the **REMOTE 1** ambient temperature reading will be used exclusively for that time period. All other sensors will be ignored.

Continued on next page...

4. Use the  or  key to make your time selection for the weekday time period.  
**Note:** If you want the fan to run continuously during this time period, select **ON** with the **FAN** key.
5. Then use the  or  key to make your setpoint selection for that weekday period.
6. Press **Next Step**.
7. Repeat steps 4 through 6 that day's other time periods.

**Saturday:**

Repeat steps 4 through 6 for Saturday time periods.

**Sunday:**

Repeat steps 4 through 6 for Sunday time periods.

**A Note About Auto Changeover:**

When in Auto you have the ability to switch between auto heat or auto cool by pressing the system key. This can be done once the current mode has reached its setpoint. For example: if in auto heat, the heat setpoint must be satisfied before the thermostat will allow you to switch to auto cool. You can switch out of auto by holding down the system key. To get back into auto, you must toggle the system key to auto.





**Set 7 Day Program Schedule****Monday:**

1. Select **HEAT** or **COOL** with the **SYSTEM** key.  
**Note:** You have to program heat and cool each separately.
2. Press the **MENU** key.
3. Press **SET SCHED**. **Note:** Monday is displayed and the **WAKE** or **OCCUPIED** icon is shown. You are now programming the **WAKE** or **OCCUPIED** time period for that day.

**Additional step if indoor remote sensor is connected.**

The master thermostat will either average all sensors (system average) or only use one sensor for the system ambient temperature (priority). The default setting is **SYSTEM AVERAGE**, which means all sensors are averaged to create the system average ambient temperature reading. The **NEXT ZONE** key can be pressed to change the priority. The system information area of the display shows the priority. For Example: There is a remote connected and it is named **REMOTE 1**. If the **NEXT ZONE** key is pressed until **REMOTE 1** is shown, then the **REMOTE 1** ambient temperature reading will be used exclusively for that time period. All other sensors will be ignored.

Continued on next page...

4. Use the  or  key to make your time selection for that days time period. **Note:** If you want the fan to run continuously during this time period, select **ON** with the **FAN** key.
5. Then use the  or  key to make your setpoint selection for that days time period.
6. Press **Next Step**.
7. Repeat steps 4 through 6 for that day's other time periods.

**Repeat steps 4 through 7 for the remaining days of the week.**



### A Note About Programmable Fan

The programmable fan feature will run the fan continuously during any time period it is programmed to be on. This is the best way to keep the air circulated and to eliminate hot & cold spots in your building.

### Next Zone (Only if indoor remote is connected)

The **NEXT ZONE** key cycles through all sensors connected to your wireless system.



**SYSTEM AVERAGE** shows the average ambient temperature of all connected sensors.

**LOCAL** shows the ambient temperature of the thermostat only.



The name of the remote sensor will show and the ambient temperature for that sensor will be displayed.



For more information please refer to the Indoor Remote Sensor User Guide.

**Keypad Lockout Note:**

If  appears in the display, then the keypad is locked. All or some of the keys will not work. Hold the  and  keys for 3 seconds to remove the lock. Use the same procedure to lock the display

**Temporary & Permanent Hold Feature**

**Temporary Hold:** The thermostat will display **HOLD** and **Run Schedule** on the bottom of your screen when you press the  or  key. If you do nothing, the temperature will remain at this setpoint temporarily for 4 hours. After this, the program setpoint will then replace your temporary setpoint.

**Permanent Hold:** With a temporary hold set, if you press the **HOLD** key at the bottom of your screen, you will see **HOLD** appear next to the setpoint temperature in the display. The thermostat will now permanently stay at this setpoint and can be adjusted using the  or  keys.

**To Return To Program:** Press the **Run Schedule** key at the bottom of your screen to exit temporary and permanent holds.

## Filter Change & Other Reminders

If your HVAC contractor has configured the thermostat to remind you when the air filter needs changed, you will see a reminder in the display when your air filter needs to be changed.

**Resetting The Filter Change Reminder:** When the reminder is displayed, you should change your air filter and reset the reminder by pressing the **CLEAN** key for 3 seconds.

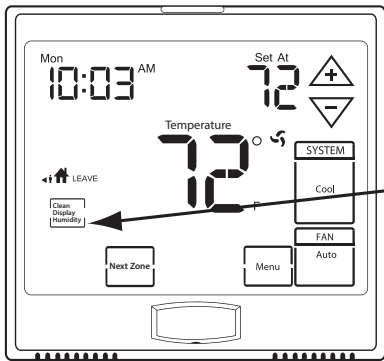

Hold down **CLEAN** for 3 seconds, to reset filter reminder.

## Warranty Registration

Your new thermostat has a 5 year limited warranty. You must register your thermostat within 60 days of installation. Without this registration the warranty period will begin on the date of manufacture. For warranty issues please contact the HVAC professional that installed this product. You can register your new thermostat in 2 ways:

### Online

Go to the company website, select warranty registration and fill out a short registration form.

### Mail

Complete the form below and mail it to the address shown.



## Warranty Registration

Name: \_\_\_\_\_ Thermostat Model: \_\_\_\_\_

Address: \_\_\_\_\_ Date Installed: \_\_\_\_\_

City: \_\_\_\_\_ Complete form and mail to:

State: \_\_\_\_\_ **Thermostat Warranty Registration**

Zip: \_\_\_\_\_ Pro1iaq

P.O. Box 3377  
Springfield, MO 65808-3377

**Cut Out For  
Warranty Registration**

